



ESTA [®]
PARKET

Contents

- 2 PURE ELEGANCE
- 8 PERFECT WHITE
- 14 DESIGNER'S SELECTION
- 18 STONEWASH
- 20 ENGRAVED
- 22 EXOTIC WOOD
- 24 SMOKED
- 26 THERMO
- 28 ESTA ART
- 29 ESTA 2 STRIP
- 30 Cleaning & Maintenance
- 32 Choice of Format
- 33 Construction Options
- 34 The Structure Drawing
- 36 ESTA Sport
- 38 GALLERY



The background features a vertical stack of horizontal wood grain patterns in various shades of brown and tan. On the left side, there is a faint, light-colored silhouette of a tree with many branches.

Find Your Style

The choice of flooring defines the style and ambience of your home. The many options within the ESTA PARKET range will transform your dreams into reality.

Hardwood timbers with their well known hard wearing properties make them ideal for parquet production. Subtle variations in the colours and tones of the wood species will add elegance and style to your home.

PURE ELEGANCE *Exclusivity, Charm and Balance*



3 Strip Ash Rustic Castle Grey Oil #8230

Pure Elegance is a harmonious combination of a classic sophisticated design and contemporary trends. This is a classical and modern collection of wood flooring that incorporates function and style with a broad selection of species and flooring styles. It is particularly designed to fit the most eclectic and delicate tastes.



1 Strip Oak Dusky Grey Brush Matt Lac.

#3593



1 Strip Oak Antique 6011 Matt Lac.

#3703

Charming and inviting, this wood flooring expresses its stylishness and exclusivity combined with the high quality, durability and longevity. This color pallet is inspired by the deep rich tones of nature: from ginger to dark brown, from greyish to an onyx black.



1 Strip Oak Village Dark Filler Matt Lac.

#1499



3 Strip Oak Honey Matt Lac.

#1499



3 Strip Oak Honey Matt Lac.

#1946



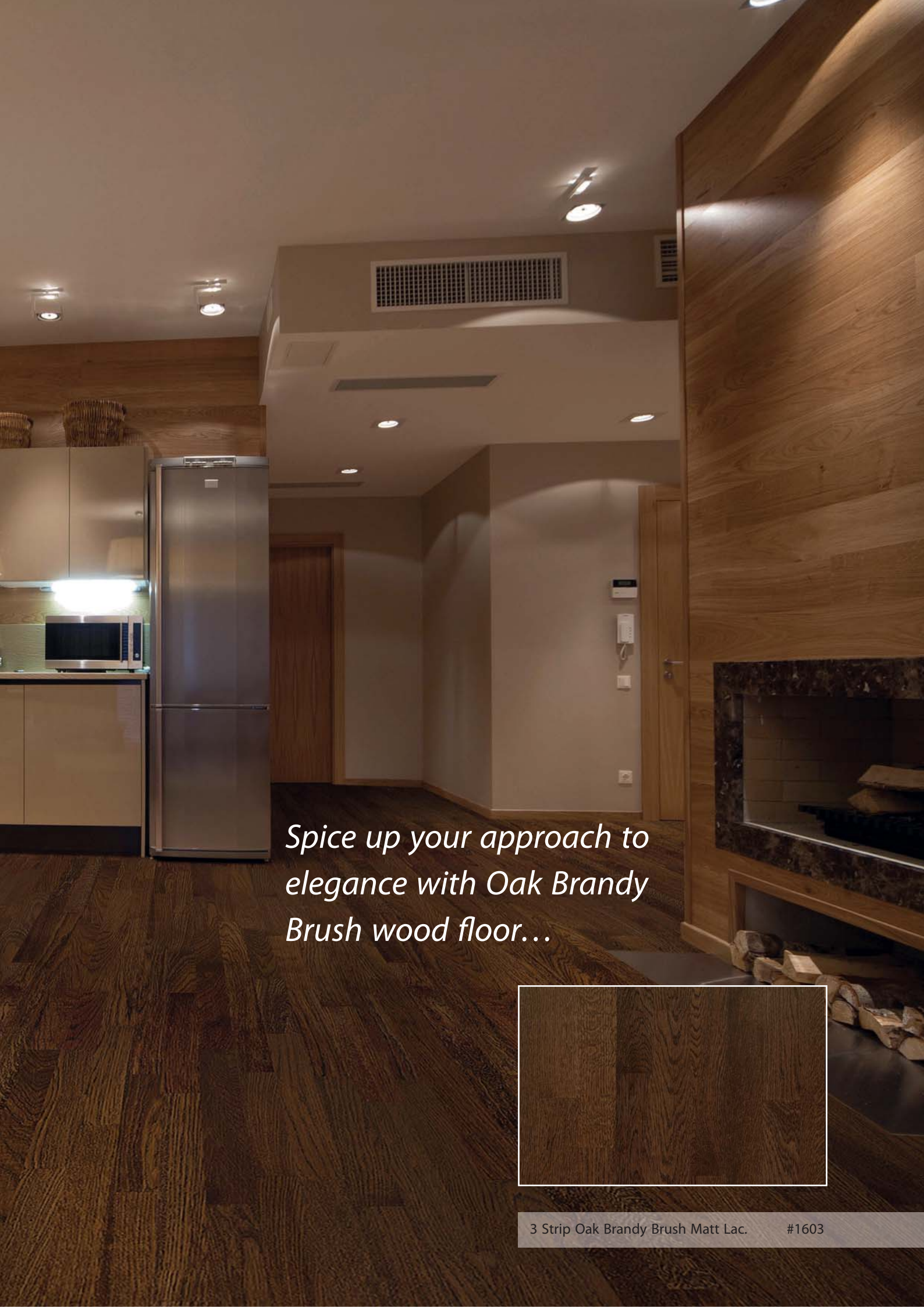

Spice up your approach to elegance with Oak Brandy Brush wood floor...





1 Strip Oak Village Dark Filler Matt Lac. #1499

This is a timeless collection that enhances values of solid and lasting beauty over time. Ash floors give a unique style to Your house. This wood specie is generally free from knots, but has an elegant natural variation of colors that show the beauty of real wood.



1 Strip Ash Natur Sandstone 2B Brush Matt Lac. #8567

PERFECT WHITE *Enhance Your Space*



1 Strip Oak Silver Moon Matt Lac. #1619



1 Strip Oak Bianco Perla Matt Lac.

#3197



1 Strip Oak Frost Ivory Pores Extra Matt Lac.

#3539

PERFECT WHITE wood flooring collection offers a range of popular whites and neutrals with intriguing tones and textures. The natural beauty of this color palette brings tranquility and serenity to a traditional home. It is creative, expressive, complimentary and conversational.



1 Strip Ash Natur Bianco Perla Matt Lac.

3529



1 Strip Oak Monaco Extra Matt Lac.

3858



If you want to enhance your living space and create clean, crisp and fresh environment, choose **Oak Monaco** this wood flooring creates a modern and versatile backdrop to any interior design.

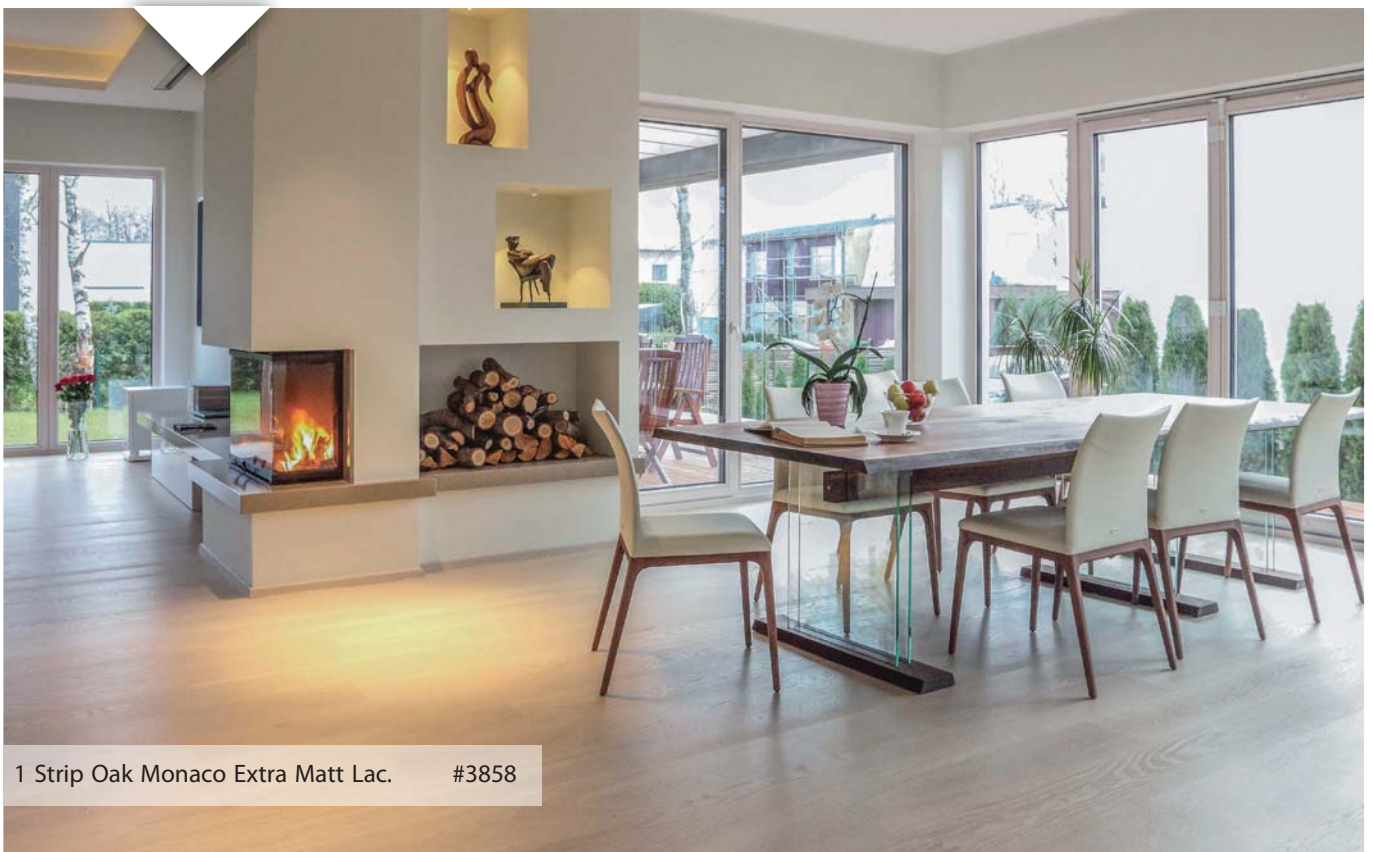

1 Strip Oak Monaco Extra Matt Lac. #3858

Reveal an inviting openness and breathe new life into your living spaces with an attractive color variations Of PERFECT WHITE...





3 Strip Oak Nordic Silver Moon Matt Lac. #1974



This white wood floor with the greyish hues can make relaxed and casual look as well as create a sophisticated and elegant, museum-like background. It fully depends on you décor elements.

Balanced, Graceful and Elegant...

1 Strip Ash Snow Matt Lac. #1190



1 Strip Oak London Extra Matt Lac. #6987



3 Strip Oak Latte Oil #3783



3 Strip Ash Rustic White Matt Lac. #1178

White wood floors are ideal for closed or open living spaces, lots of light, or dimly lit rooms. Whites and neutrals are the perfect background to give free rein to your imagination and create your dream living space.

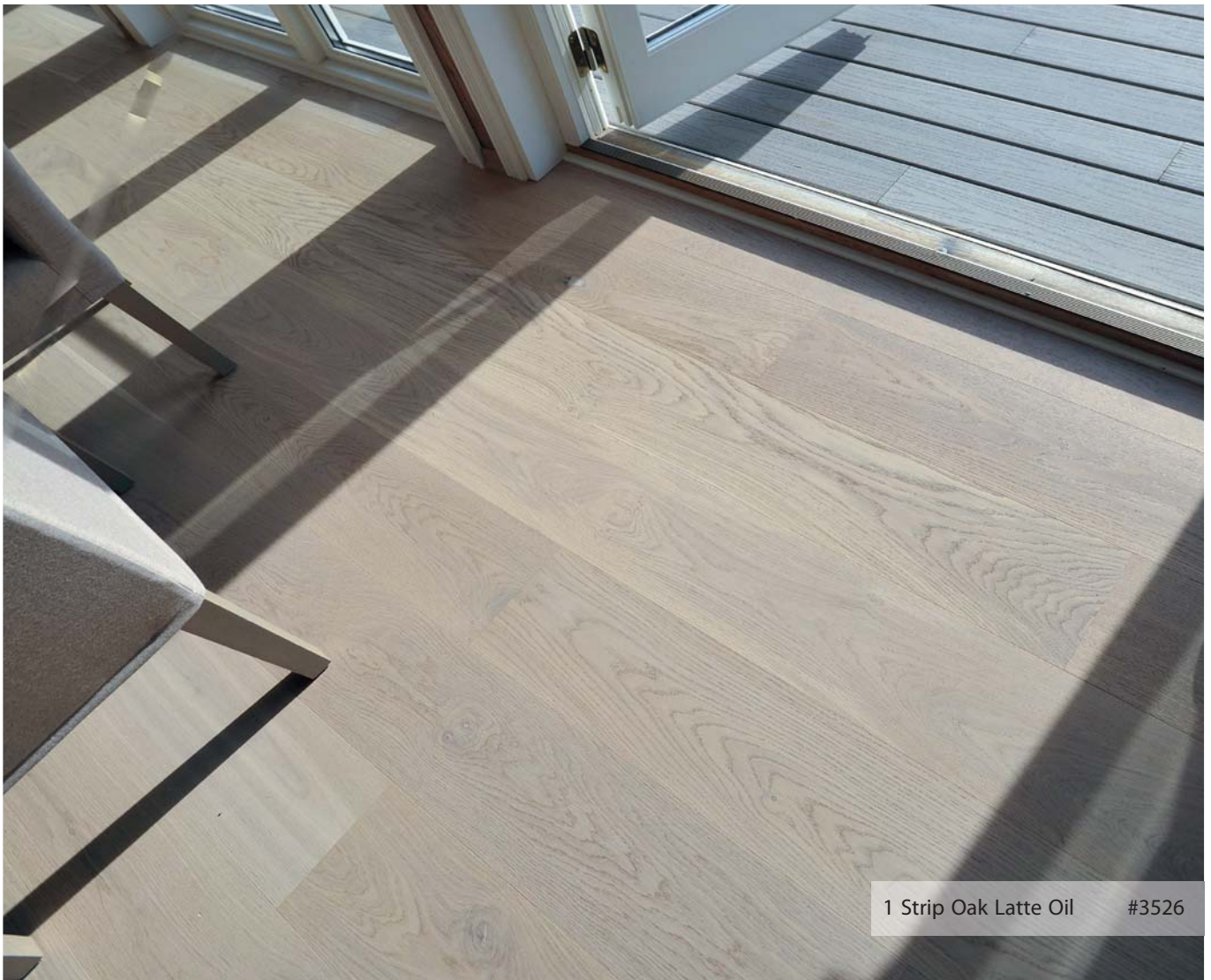

1 Strip Oak Latte Oil #3526

DESIGNER'S SELECTION

Creative, Inspiring, Individual



1 Strip Oak Dune White Pores Matt Lac. # 1551

DESIGNER'S SELECTION is a collection of wire-brushed floors where the grains of wood are stained in a differing color that of the surface. This allows designers to suit same floor to multiple interior designs.

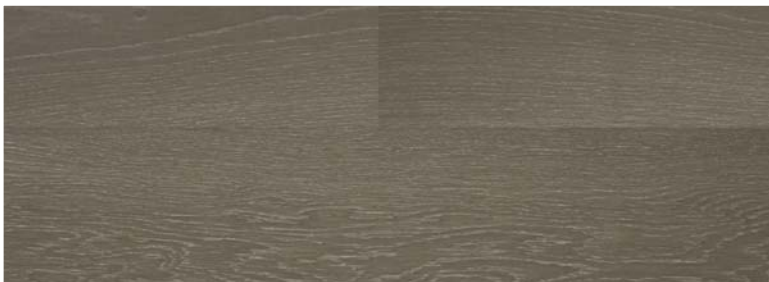

1 Strip Oak Dusky Grey Ivory Pores Matt Lac.

#3236



1 Strip Oak Rose Ebony Pores Matt Lac.

#1571





Designer's selection brings out the inherent uniqueness of the wood, full of natural variation and character with eye-catching grain lines.

Variation of tones and subtle contrast of lights and darks in the wood floor provides you with a great opportunity to mix and match furniture and decoration accessories in your space.



1 Strip Oak Kose Grey Pores Matt Lac.

#3846



1 Strip Oak Mona Grey Matt Lac.

#1615



3 Strip Oak Brandy Pores Matt Lac.

#1865





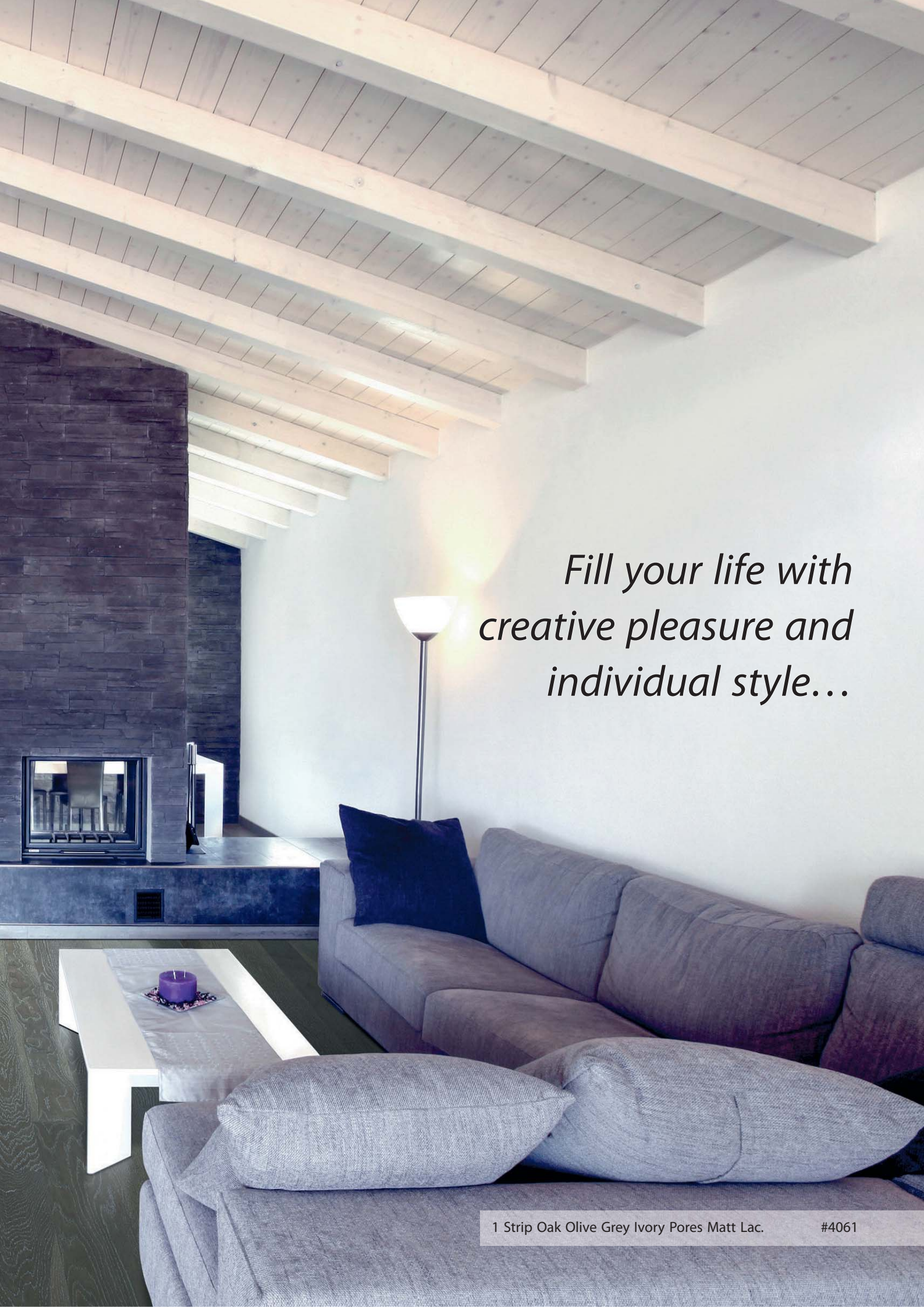

*Fill your life with
creative pleasure and
individual style...*

STONEWASH COLLECTION

This Collection also includes selection of impressive Oak floors features a subtle combination of two beautiful finishes without rough colors transitions. The unique manufacturing process enables to create stained pores in natural tones that enhance the beauty of the wood rather than cover it. A delicately accentuated grain patterns of the wood with uniform colors that magnificently complement each other.

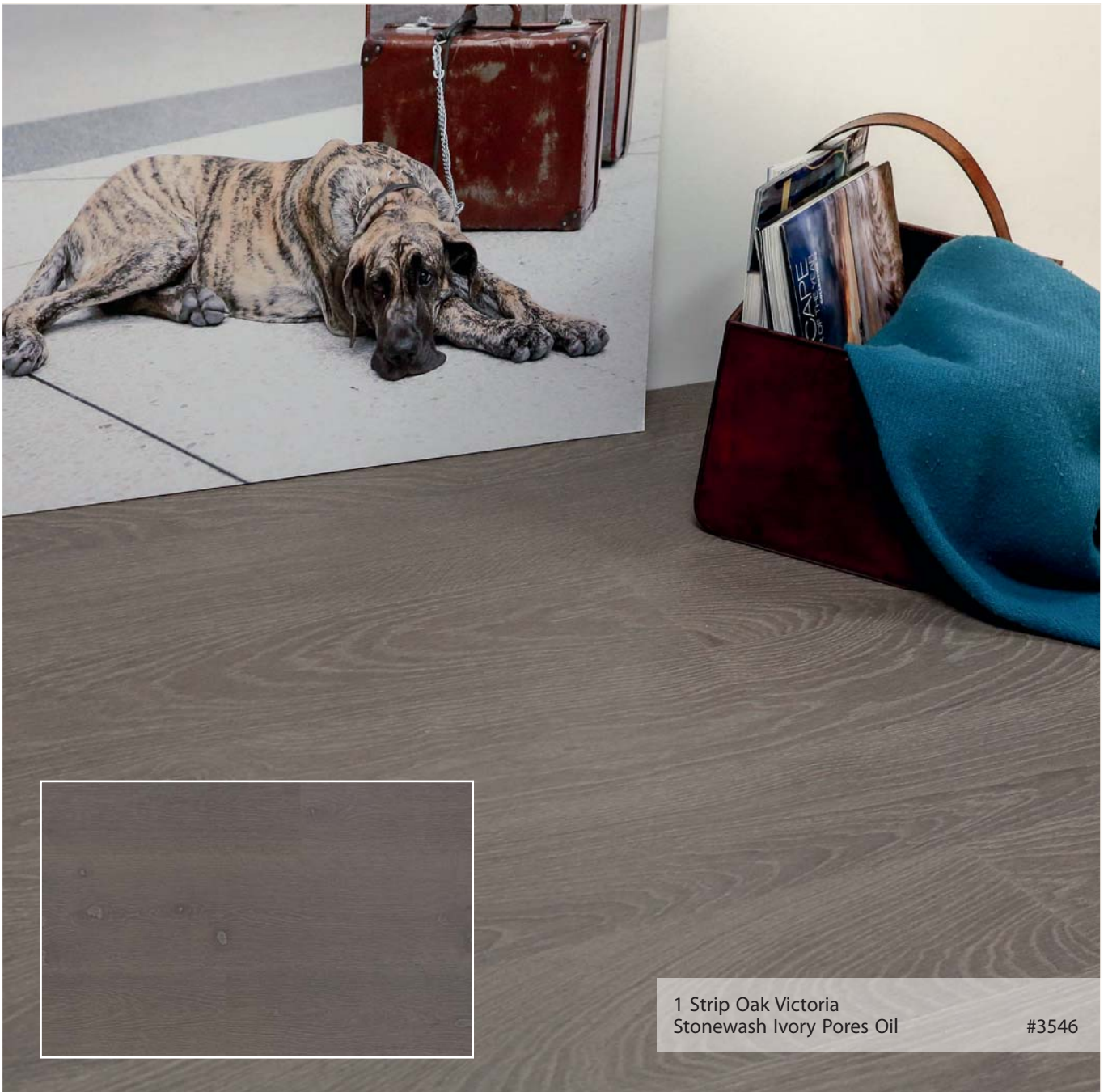

1 Strip Oak Victoria
Stonewash Ivory Pores Oil

#3546

Each design has its own narrative that captures the imagination...



1 Strip Oak Olive Grey Stonewash Ivory Pores Oil #8420



1 Strip Oak Amber Stonewash Ivory Pores Oil #3514



1 Strip Oak Dune Stonewash Ivory Pores Oil #3887



1 Strip Oak Ebony Stonewash Ivory Pores Matt Lac. #8690



1 Strip Oak Dusky Grey Stonewash Ivory Pores Oil #3533

ENGRAVED COLLECTION

Extraordinary by Nature



1 Strip Ash Honey Matt Lac. Engraved #3546



1 Strip Oak City Oil Engraved #3289



1 Strip Ash White Oil Engraved #3277



3 Strip Oak Bitter Matt Lac. Engraved #3297



3 Strip Walnut Oil Engraved #3301

Engraving is a special surface treatment that applies a rich and distinctively individual pattern on the floor surface. It reveals dynamic character and enhances the texture of the wood to give your floor an absolutely stunning and creative style.



3 Strip Ash Rustic Bitter Pores Oil Engraved #3295



3 Strip Oak Thermo Engraved Matt Lac. #3293



1 Strip Oak Bitter Pores Engraved Matt Lac. #3287

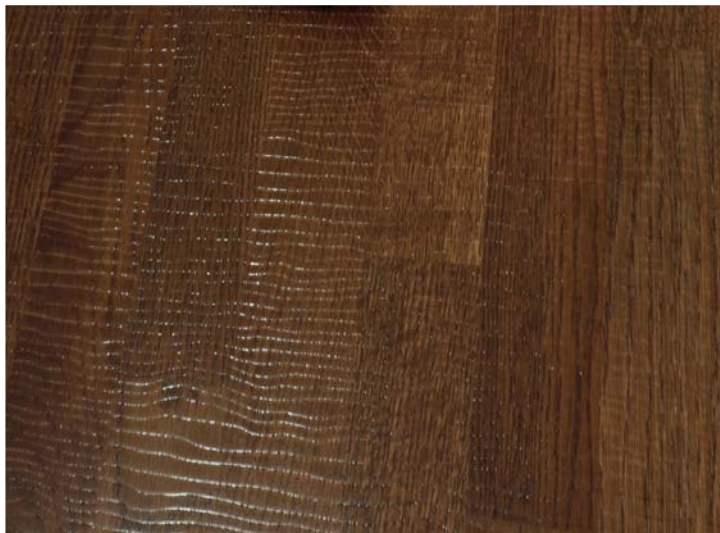

3 Strip Oak Brandy Matt Lac. Engraved #3842



EXOTIC WOOD

Striking Elegance, Sophistication, Durability

Exotic Wood flooring provides a timeless classic elegance with stylish, ultimately luxurious home design. Those floors have unique character and natural beauty with high performance and durability.



3 Strip Jatoba Matt Lac. #1361



1 Strip Jatoba Matt Lac. #1398



1 Strip Walnut City Matt Lac. #2025



3 Strip Walnut City Matt Lac. #1455



1 Strip Teak Matt Lac. #3420

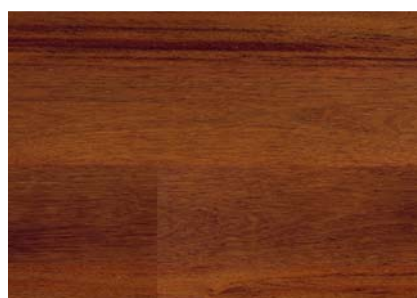

1 Strip Merbau Matt Lac. #3816



3 Strip Merbau Matt Lac. #3700



SMOKED *Deep, Rich and Natural*



3 Strip Oak Nordic Smoked Oil #6523

Smoked wood flooring creates a dramatic, dignified style, adds elegance and depth to a room, and is ideal for both traditional and modern interiors.



3 Strip Oak Nordic Smoked Oil

#6523



1 Strip Oak Smoked Brush 2B
(Sapwood Present) Matt. Lac.

#8552

Smoking gives Oak wood a natural looking color change ranging from a warm rich brown color to completely dark and almost black tones.

It results in balanced, durable and wear-resistant product that stands up to moisture and temperature fluctuation.



1 Strip Oak Smoked Matt Lac.

#1663



3 Strip Oak Smoked Matt Lac.

#3557



1 Strip Oak Smoked S Matt Lac.

#4108



3 Strip Oak Smoked S Matt Lac.

#8201

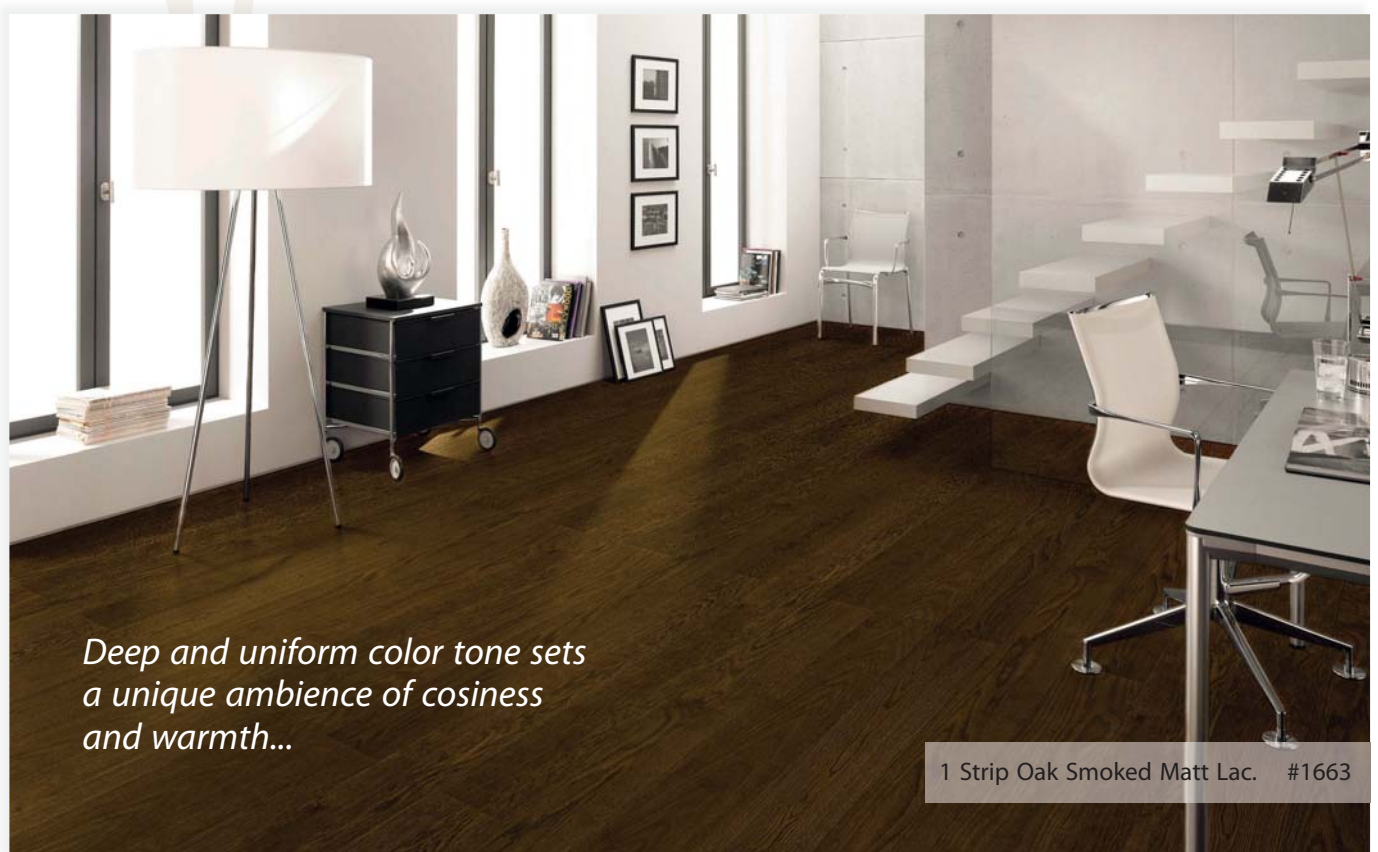

Deep and uniform color tone sets a unique ambience of cosiness and warmth...

1 Strip Oak Smoked Matt Lac. #1663

THERMO *Warmness, charm and royal splendour*



Thermo collection creates a gentle feeling of warmness and fill your interior with simple natural richness.

The color palette varies from a mahogany brown to a walnut dark brown color, giving the look of an exotic wood, and the color is consistent beyond the surface.

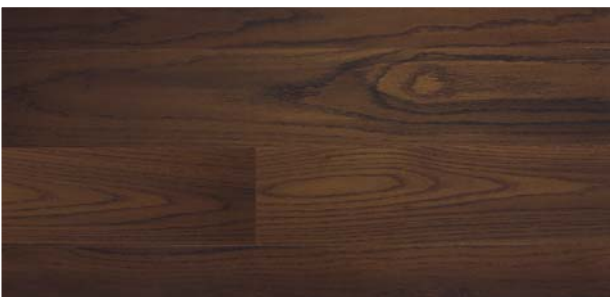

1 Strip Oak Thermo Matt Lac.

#1699



3 Strip Oak Thermo Matt Lac.

#2023



3 Strip Oak Thermo White Pores Matt Lac.

#2027



1 Strip Oak Thermo White Pores Matt Lac.

#2001

Get an authentic elegance and magnificence with an allure of thermo-treated wood floors...



1 Strip Ash Thermo Dark Ebony Pores Matt Lac. #1205



3 Strip Ash Golden Thermo Ebony Pores Matt Lac. #1157



1 Strip Ash Golden Thermo Matt Lac. #1080



3 Strip Ash Golden Thermo Matt Lac. #1161



1 Strip Ash Dark Thermo Ebony Pores Matt Lac. #1205

ESTA ART

A timeless look of Reinessanse-style-inspired floor pattern with the contemporary flair for an impressively elegant appearance...

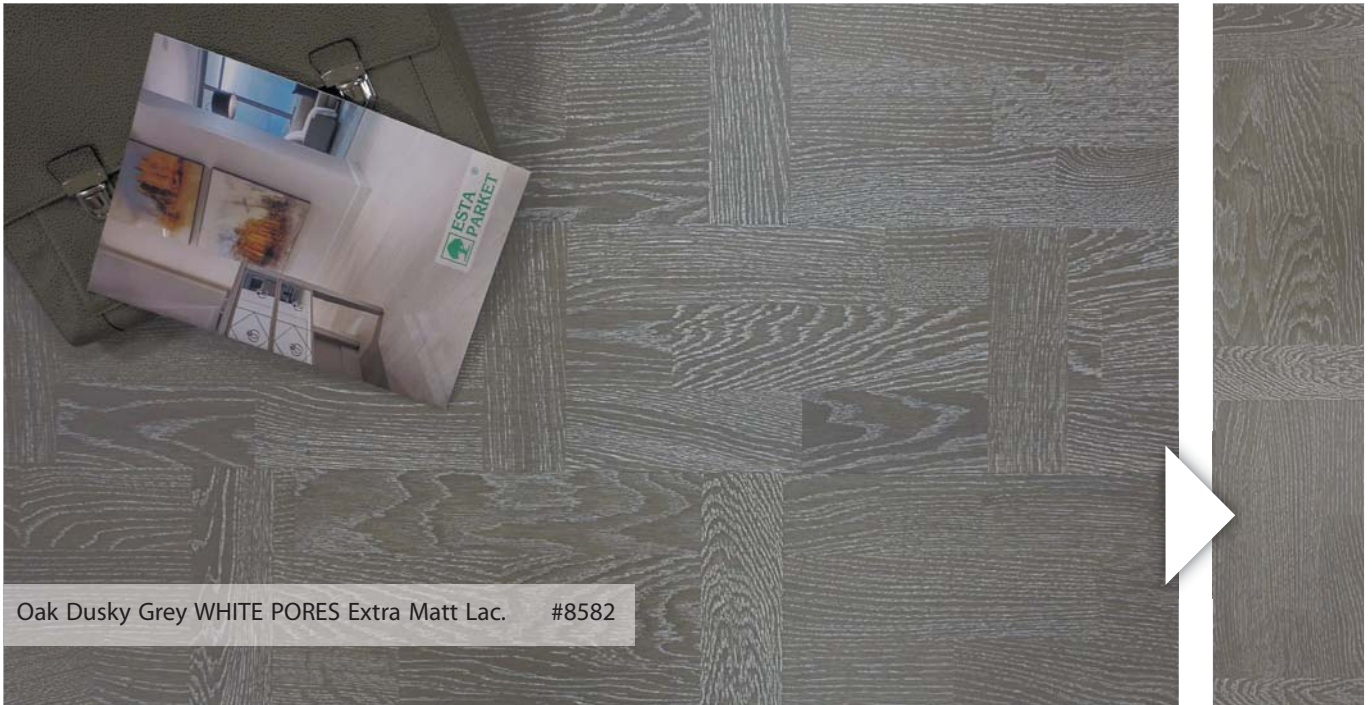

Oak Dusky Grey WHITE PORES Extra Matt Lac. #8582

Art wood flooring Collection is a return to vintage European design.

Embracing color variations with stained pores of different intriguing tones add eye-catching distinction to already unique planks.



Oak Silver Moon Matt Lac.

#3971



Oak Mona Grey Matt Lac.

#8583



Oak Quartz White Pores Matt Lac.

8584



Oak Kose Grey Pores Matt Lac.

#8581



Oak Dune White Pores Matt Lac.

#8758

ESTA 2 STRIP *Optimal alternative to 1 Strip floor*



2 Strip Oak White Matt Lac.

#1752



2 Strip Oak Natur Matt Lac.

#3870



2 Strip Oak Castle Grey Oil

#3271



2 Strip Oak Ebony Oil

#3275



2 Strip Oak Dune Brush Extra Matt Lac.

#3638



2 Strip Oak Stone Grey Oil

#3839



2 Strip Oak White Matt Lac. #1752

CLEANING & MAINTENANCE

Any kind of hardwood floor adds not only charm but beauty to almost any room, but like most types of flooring, they need regular care on a regular basis to maintain their quality appearance.

Air temperature and air moisture:

- Parquet boards are produced of 100% natural timber. Therefore significant moisture variations can influence it.
- It is important to maintain the relative humidity in the room as stable as possible. Our recommended humidity is RH 40–60%.
- Recommended average temperature is 14–23 C.

General Care and Damage Prevention:

- Please monitor moisture and temperature as set out above and take corrective measures if necessary.
- Place doormats on both sides of your front door.
- Remove any grit or other abrasives immediately.
- Immediately wipe up liquid spills.
- If you spill (food or drinks), wipe up immediately with cloth or paper towels to prevent any permanent damage or staining.
- Protect all furniture with felt pads to avoid any scratching with movement.
- Close curtains or blinds to limit direct sun exposure.
- Avoid wearing high-heeled shoes on the floor, as they can dent or scratch the floor.
- Keep pet's nails trimmed to minimize damage to the surface.



GENERAL CLEANING

DRY CLEANING: Floors should be cleaned daily using dry cleaning methods, such as vacuum, soft broom or scissor mop. It is important to remove any abrasive particles of grit and dirt which may scratch the lacquered surface when trafficked under footwear, chair legs, and other items moved across the floor.

DAMP CLEANING:

- When necessary, the floor can be washed with a mild detergent (pH 6–8).
- Dip the mop into the bucket of prepared cleaning solution, wring it out completely, mop in the direction of the wood grain and repeat.
- When the water gets dirty, empty the bucket, mix a new batch of cleaning solution and continue mopping.

MOPPING TECHNIQUE:

- Always keep water to a minimum when cleaning your floors.
- Water is wood's worst enemy, so use a damp mop rather than a soaking wet one.
- Wipe up any spilled liquids and avoid any standing water or liquid as wood will absorb liquid and expand which could effect the stability of the floor.
- Do use a floor-cleaning product recommended by the floor finisher or opt for plain soap and water.

GENERAL AFTER-CARE

LACQUERED WOOD FLOOR

- Normal cleaning to remove surface debris is accomplished using a broom or vacuum cleaner
- To remove normal stains and dirt, the floor should be cleaned with a lacquered floor cleaning spray.
- Simply spray evenly across the floor, allow a minute to work on any stubborn marks and simply mop over.

OILED WOOD FLOOR

Maintaining with maintenance oil:

- After a certain period of use, the oiled floor will perhaps look slightly worn and matt and should be maintained with a small quantity of Maintenance Oil.
- Before oiling, clean the floor with a cleaner mixed with water.
- Maintenance Oil should be sprayed onto the floor and immediately polished in by hand or with polishing machine.
- Respray with oil if necessary.
- After approx. four to five hours (at 18–20 degrees Celsius) the floor may be used again.
- After 24 hours, the floor may be cleaned with soap.

CHOICE OF FORMAT



CONSTRUCTION OPTIONS

- Birch Plywood Core (multilayer parquet)



- 3 Layer Construction (bottom layer – birch veneer, core layer – solid pine strips, top layer – precious wood (Oak, Ash etc.)



Both constructions can be made in different thickness

14 mm with top layer thickness above 3 mm (Standard Construction)

- Most popular construction with installation on concrete floor with underlayment.
- Efficient floating installation with Click system.



16 mm thick with 6 mm top layer

- Possibility to have a long lasting 6 mm top layer on the parquet suitable for installation on concrete floor with underlayment. Such floor can be sanded as many times as solid parquet. The solution is outstanding for rooms, where advantages of solid floor are required but keeping the minimal floor height is important.



Alternative to Solid Floor

22 mm thick with 6 mm top layer

- Same useful thickness top layer as on solid floor
- Parquet can be installed straight to the beams with no need for the subfloor
- Higher stability due to sandwich construction
- Considerably Greener (Less hardwood trees will be used by manufacturing of same m² compared to solid floor)
- Floor can be sanded as many times as solid wood floor



22 mm thick boards with top layer thickness above 3 mm

Parquet can be installed straight to the beams with no need for the subfloor



- Higher stability due to sandwich construction
- Considerably Greener (Less hardwood trees will be used by manufacturing of same m² compared to solid floor)

THE STRUCTURE DRAWING & EXPLANATION

- All wood materials used in the production of ESTA PARKET are dried /conditioned within our factory complex, and this guarantees stability of the boards construction.
- Flooring boards are glued at low temperatures, there is no inner tension like in solid wood within the components making up the finished product, and therefore they perform better as a laid floor.
- The bottom layer is a Birch veneer, that adds to the board stability.
- The resins used in production are non-toxic, and the parquet complies with the severest health requirements.
- ESTA PARKET is recommended to be used over under floor heating. Our parquet performs well even under Scandinavian variations of moisture and temperature.



WOOD HARDNESS

The Brinell scale defines the hardness of wood. The higher the scale reading – the better the wood resists impacts and wear. The Brinell readings below were taken at 12% moisture content of the wood.

Please note that none of the wood species can resist essential spot impacts – a drop of heavy articles, for example. For the same reason it is recommended to glue soft felt pads to furniture legs.

	SOFT	MEDIUM	HARD	
Jatoba				7,0 - 7,7
Merbau				4,1 - 4,9
Ash				3,3 - 4,1
Oak				2,9 - 3,7
Walnut				2,8 - 3,5
Birch				2,2 - 2,7

ESTA CLICK PATENTED

- ESTA PARKET boards with click locking can be installed easily and quickly. No glue is necessary to fix the boards.
- The boards will close tight against each other once they are locked.
- Tight locking protects the boards against occasional spill of water.

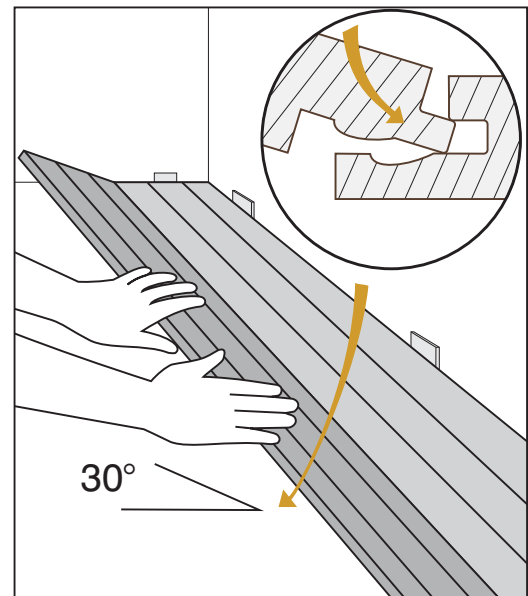

TOP (WEAR) LAYER

- The top layer/plank of valuable wood is available in thickness 3,0–6,4 mm. After installation it can be sanded several times, if the need be.
- The top layer is finished with environment-friendly lacquers or oils that do not contain solvents or formaldehyde, and do not give off any hazardous gases.

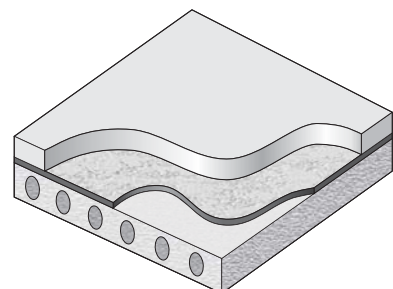

ESTA SPORT

For Top Layers of Sports Floor we offer 3 strip Oak, Ash, Beech, Merbau and Maple in thickness 3.5 or 6 mm for Long Life products. Any of the presented species can be offered stained. Please note that there is a possibility of making 9 strip flooring on plywood core.

- The sports floor supplied by Esta Parket to Sport Events like Olympic Games in London 2012 has demonstrated a great performance.



Esta Parket uses sports lacquers from top manufacturers whose products are certified with EN-14904 athletic floor performance standard.



KLUMPP
COATINGS

Dance and Sports Floor solutions available upon request

CLIMATE

To minimize the expansion or contraction of your floor, the building should be well ventilated and relative humidity level maintained between 40%–60% at all times, before You bring parquet to the sight. Before the floor installation, painting, plastering and cement work must be completely dry. Parquet boards must be left in the room unpacked to acclimatize at a temperature between 14°C–23°C for a period of at least 48 hours at a relative humidity level between 40%–60%.

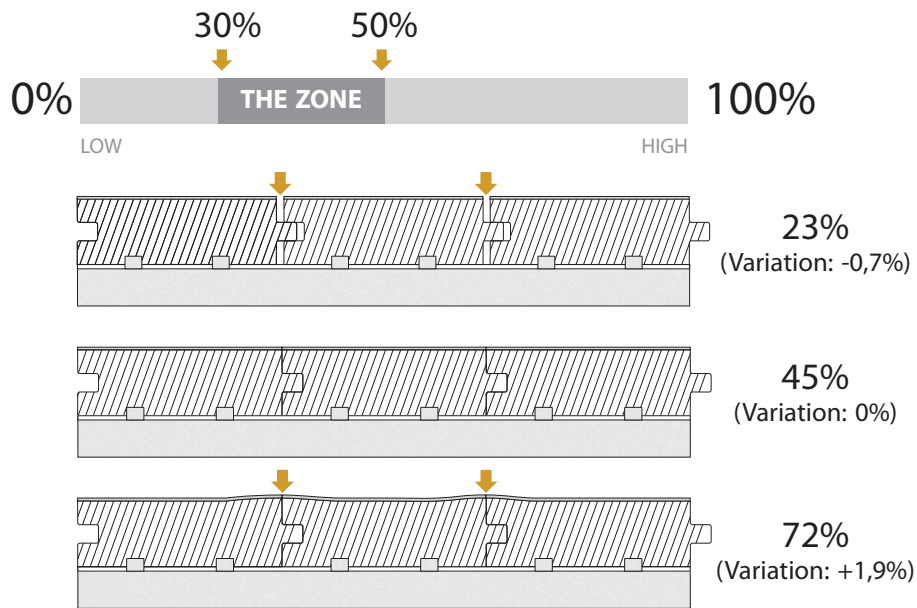

PARQUET BOARDS AND HEATED FLOORS

Floors with underfloor heating are more and more popular.

For heated floors we recommend to use ESTA PARKET 14 mm thick either laid as a floating floor, or glued down to the subfloor.

Glued down floors distribute the heat more uniformly. The heating system should be adjusted so that the parquet temperature never exceeds +27°C.

The maximum variation in temperature should not be more than +5°C within 24 hours.



Selection of Natural Oak

Wood is a natural living material with colour and structure pattern variation. Following design grading are selected at the factory.

	CALM	LIVING	ROUGH
City			
Elite Dark			
Town			
Village			
Ranch			



1 Strip Oak City Matt Lac. 2B



3 Strip Oak City Matt Lac.



1 Strip Oak Town Matt Lac.



3 Strip Oak Town Matt Lac.



1 Strip Oak Village Matt Lac.



3 Strip Oak Village Matt Lac.

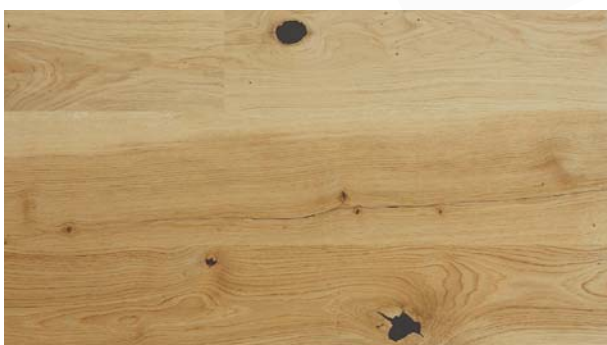

1 Strip Oak Ranch Matt Lac.



1 Strip Oak Elite Dark Matt Lac.

Selection of Natural Ash

Ash is optimal alternative to oak floors, with identical wood hardness. Naturally Ash is almost knot free. Higher selections of Ash are very bright and naturally light color. More rustic selections show high contrast in colours from creamy white to pale tan with the heartwood being light to chocolate brown.

	CALM	LIVING	ROUGH
City			
Elite			
Town			
Village			
Rustic			



1 Strip Ash Elite Matt Lac.



1 Strip Ash Village



1 Strip Ash City Matt Lac.



1 Strip Ash Town Matt Lac.



3 Strip Ash Rustic Matt Lac.



3 Strip Ash Elite Matt Lac.

**PERFECT
WHITE
Oak**



1 Strip Oak Silver Moon AB #1619
Matt Lac.



1 Strip Oak Bianco Perla #3197
Matt Lac.



1 Strip Oak Frost Ivory Pores #3539
Extra Matt Lac.



1 Strip Oak Ivory Brush #4111
Matt Lac.



1 Strip Oak Latte Oil #3875



1 Strip Oak Monaco Extra #3858
Matt Lac.



1 Strip Oak City White #1475
Matt Lac.



1 Strip Oak White Brush #1715
Matt Lac.



1 Strip Red Oak White Matt Lac. #6487



1 Strip Oak WF Whited #3609
Matt Lac.



1 Strip Oak London Extra #6987
Matt Lac.



1 Strip Oak Dazy Brush #3794
Matt Lac.



1 Strip Oak Cream Ivory Pores #3791
Matt Lac.



1 Strip Oak Pearl Matt Lac. #1567



1 Strip Oak Pearl White Filler #3660
Matt Lac.



2 Strip Oak White Oil #8888



2 Strip Oak Monaco Extra #3884
Matt Lac.



2 Strip Oak Latte Matt Lac. #3526



2 Strip Oak London Extra #8080
Matt Lac.



3 Strip Oak Bianco Perla #3778
Matt Lac.



3 Strip Oak Cotton White #1881
Matt Lac.



3 Strip Oak Silver Moon #1861
Matt Lac.



3 Strip Oak Nordic Silver #8327
Moon Matt Lac.



3 Strip Oak Frost Ivory #8874
Pores Oil



3 Strip Oak White Brush #2011
Matt Lac.



3 Strip Oak Latte Oil #3783



3 Strip Oak Monaco Extra #8875
Matt Lac.



3 Strip Oak Ivory Brush #2067
Matt Lac.



3 Strip Oak WF White #8878
Matt Lac.



3 Strip Oak London Ivory Pores Extra Matt Lac. #8652



3 Strip Oak London Extra Matt Lac. #8017



3 Strip Oak Dazy Brush Matt Lac. #8877



3 Strip Oak Nordic White Matt Lac. #1906



3 Strip Oak Nordic Pearl Matt Lac. #1784



PERFECT
WHITE
Ash



1 Strip Ash Natur Bianco Perla Matt Lac. #3528



1 Strip Ash Elite White Matt Lac. #3618



1 Strip Ash Village White 2B Matt Lac. #3629



1 Strip Ash Natur Snow Matt Lac. #1190



3 Strip Ash Elite Bianco Perla Matt Lac. #3833



3 Strip Ash Silver Moon Matt Lac. #1175



3 Strip Ash Elite White Matt Lac. #1149



3 Strip Ash Rustic Bianco Perla Matt Lac. #3185



3 Strip Ash Rustic White Matt Lac. #1178

**PURE
ELEGANCE**
Oak



1 Strip Oak Village Dark Filler #1499
Matt Lac.



1 Strip Oak Town Low Gloss #2727
Matt Lac.



1 Strip Oak Ranch Matt Lac. #8877



1 Strip Oak Stone Grey Oil #8892



1 Strip Oak Satin Grey #3222
Matt Lac.



1 Strip Oak Dune Brush #2020
Matt Lac.



1 Strip Oak Sandstone #3224
Matt Lac.



1 Strip Oak Dune Matt Lac. #1595



1 Strip Oak Victoria Oil #3552



1 Strip Oak Dusky Grey #3593
Brush Lac.



1 Strip Oak Teak Matt Lac. #8881



1 Strip Oak Elite Dark Oil #3549



1 Strip Oak Honey Matt Lac. #1563



1 Strip Oak Antique 6011 #3703
Matt Lac.



1 Strip Oak Nero Brush Oil #3234



1 Strip Oak Antique Brush Matt Lac. #2005



1 Strip Oak Castle Grey Oil #3588



1 Strip Oak Castle Grey Brush Matt Lac. #8889



1 Strip Oak Chocolate 2B Oil #3232



1 Strip Oak Cocoa Matt Lac. #8883

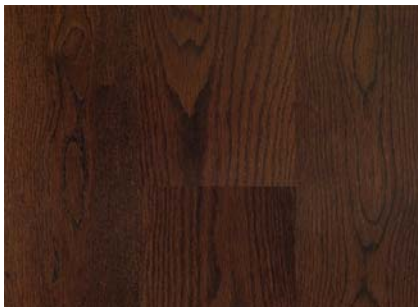

1 Strip Oak Red Matt Lac. #3989



1 Strip Oak Brandy Brush Matt Lac. #8879



1 Strip Oak Smoky Matt Lac. #3536



1 Strip Oak Thermo S Matt Lac. #8885



1 Strip Oak Brandy Matt Lac. #1603



1 Strip Oak Ebony Brush 2B Matt Lac. #1739



1 Strip Oak Ebony Matt Lac. #3850



1 Strip Oak Amaretto Light Brush Matt Lac. #1735



1 Strip Oak Bitter Brush Matt Lac. #2013



1 Strip Oak Dark Brown Oil #3216



1 Strip Oak Noire Oil #1979



1 Strip Oak Onyx Brush Matt Lac. #3695



2 Strip Oak Dune Oil #9007



2 Strip Oak Dune Brush Oil #3273



2 Strip Oak Castle Grey Oil #3271



2 Strip Oak Ebony Oil #3275



3 Strip Oak Town Matt Lac. #1918



3 Strip Oak Sandstone Matt Lac. #3786



3 Strip Oak Oak Satin Grey Matt Lac. #3309



3 Strip Oak Dune Matt Lac. #1958



3 Strip Oak Oak Dusky Grey Brush Matt Lac. #2055



3 Strip Oak Honey Matt Lac. #1946



3 Strip Oak Antique 6050 Matt Lac. #1841



3 Strip Oak Teak Matt Lac. #8882



3 Strip Oak Victoria Oi #8884



3 Strip Oak Dune Brush Matt Lac. #2015



3 Strip Oak Red Matt Lac. #3735



3 Strip Oak Brandy Matt Lac. #1930



3 Strip Oak Brandy Brush Matt Lac. #8880



3 Strip Oak Antique 6011 Matt Lac #1760



3 Strip Oak Walnut Color Matt Lac. #9010



3 Strip Oak Smoky Matt Lac. #3725



3 Strip Oak Ebony Matt Lac. #1837



3 Strip Oak Castle Grey Matt Lac. #8886



3 Strip Oak Bitter Brush Matt Lac. #1979



3 Strip Oak Antracite Matt Lac. #1950



PURE
ELEGANCE
Ash



1 Strip Ash City 2B Matt Lac. #3626



1 Strip Ash Village Matt Lac. #1109



1 Strip Ash Urban Rose Matt Lac. #1099



1 Strip Ash Sandstone Brush Matt Lac. #8567



1 Strip Ash Natur Stone Grey Oil #3250



1 Strip Ash Urban Dusky Grey Brush Oil #3258



1 Strip Ash Victoria Matt Lac. #8897



1 Strip Ash Natur Dusky Grey Oil #3256



1 Strip Ash Amber Matt Lac. #3240



1 Strip Ash Honey Matt Lac. #2002



1 Strip Ash Teak Color Matt Lac #9008



1 Strip Ash Dune Matt Lac. #8896



1 Strip Ash Castle Grey Oil #8230



1 Strip Ash Brandy Brush Matt Lac. #3633

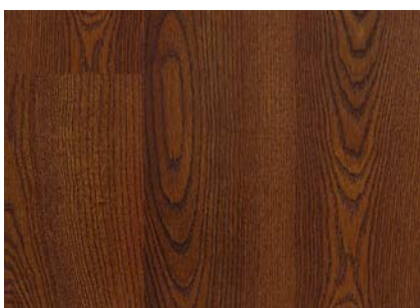

1 Strip Ash Merbau Color Matt Lac #9009



1 Strip Ash Chestnut Matt Lac. #1096



1 Strip Ash Walnut Color Matt Lac #9000



3 Strip Ash Elite Matt Lac. #1153



3 Strip Ash Rustic Matt Lac. #1181



3 Strip Ash Elite Rose Matt Lac. #1138



3 Strip Ash Honey Matt Lac. #1166



3 Strip Ash Rustic Dusky Grey Oil #3187



3 Strip Ash Stone Grey Matt Lac. #3809



3 Strip Ash Castle Grey Oil #8230



3 Strip Ash Antique 6050 Matt Lac. #1123



3 Strip Ash Chestnut Matt Lac. #1132



3 Strip Ash Dune Matt Lac. #3347



3 Strip Ash Dune Brush Matt Lac. #3195



3 Strip Ash Grey Matt Lac. #3896



3 Strip Ash Brandy Brush Matt Lac. #1126



3 Strip Ash Red Matt Lac. #2017



3 Strip Ash Brandy Brush Matt Lac. #8894



3 Strip Ash Amaretto Light
Brush Matt Lac. #1119

**DESIGNER'S
SELECTION**
Oak



1 Strip Oak Ivory Pores
Matt Lac. #6516



1 Strip Oak Rose Ebony Pores
Matt Lac. #1571



1 Strip Oak Amber Stonewash
Ivory Pores Oil #3514



1 Strip Oak Bremen Ivory
Pores Matt Lac. #4040



1 Strip Oak Dusky Grey
Stonewash Ivory Pores Oil #3533



1 Strip Oak Dune White
Pores Matt Lac. #1551



1 Strip Oak Kose Grey Pores
Matt Lac. #6152



1 Strip Oak Olive Grey Ivory
Pores Oil #4061



1 Strip Oak Olive Grey
Stonewash Ivory Pores Oil #8420



1 Strip Oak Dusky Grey
Ivory Pores Matt Lac. #8900



1 Strip Oak Dune Stonewash
Ivory Pores Oil #3887



1 Strip Oak Dune Ivory
Pores Oil #8903



1 Strip Oak Victoria Stonewash
Ivory Pores Oil #3546



1 Strip Oak Ancona 2B
Matt Lac. #8915



1 Strip Oak Brandy Pores
Matt Lac. #1587



1 Strip Oak Ebony Stonewash
Ivory Pores Oil #8690



2 Strip Oak Kose Grey Pores
Matt Lac. #3499



3 Strip Oak Ivory Pores
Matt Lac. #8916



3 Strip Oak Bremen Ivory
Pores Matt Lac. #8904



3 Strip Oak Rosev Ebony
Pores Matt Lac. #1849



3 Strip Strip Oak Dune White
Pores Matt Lac. #1857



3 Strip Strip Oak Dusky Grey
Ivory Pores Matt Lac. #9006



3 Strip Oak Brandy Pores
Matt Lac. #1865



3 Strip Oak Olive Grey Ivory
Pores Matt Lac. #8901



3 Strip Oak Dune Ivory Pores
Matt Lac. #6925



3 Strip Oak Ebony Pores
Matt Lac. #1877



3 Strip Oak Quartz White
Pores Matt Lac. #3363

**DESIGNER'S
SELECTION**
Ash



1 Strip Ash Elite Ebony Pores #8900
Matt Lac.



1 Strip Ash Antracite Matt Lac. #3252



3 Strip Ash Elite Ebony Pores #8905
Matt Lac.



3 Strip Ash Amaretto Natural #8906
Pores Matt Lac.

SMOKED



1 Strip Oak Smoked Brush #8907
2B (Sapwood Present) Matt Lac.



1 Strip Oak Smoked #8908
White Oil



1 Strip Oak Smoked Matt Lac. #1663



1 Strip Oak Smoked S Matt Lac. #4108



3 Strip Oak Nordic Smoked Oil #6523



3 Strip Oak Smoked Matt Lac. #3557



3 Strip Oak Smoked S #8201
Matt Lac.

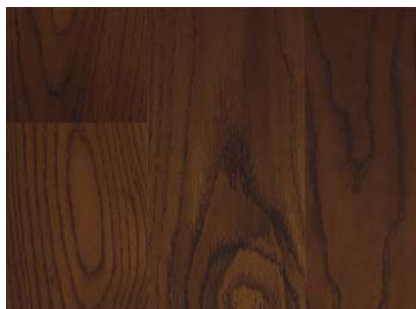

1 Strip Oak Thermo Matt Lac. #1699



1 Strip Oak Thermo Brush Matt Lac. #8911



1 Strip Oak Thermo Brush Oil #8917



1 Strip Oak Thermo White Pores Matt Lac. #2001



3 Strip Oak Thermo Matt Lac. #2023



3 Strip Oak Thermo Ebony Pores Matt Lac. #2031



3 Strip Oak Thermo White Pores Matt Lac. #2027



1 Strip Ash Golden Thermo Lac. #1080



1 Strip Ash Dark Thermo Ebony Pores Matt Lac. #1205



3 Strip Ash Golden Thermo Lac. #1161



3 Strip Ash Golden Thermo Ebony Pores Lac. #1157



3 Strip Ash Dark Thermo Ebony Pores Matt Lac. #8913



1 Strip Oak City 200C
Oil Engraved #3289



1 Strip Oak Village
Oil Engraved #3291



1 Strip Oak Bitter Pores
Matt Lac. Engraved #3287



1 Strip Oak Brandy
Matt Lac. Engraved #3842



3 Strip Oak Honey
Matt Lac. Engraved #3299



3 Strip Oak Bitter
Matt Lac. Engraved #3297



3 Strip Oak Thermo
Matt Lac. Engraved #3293



1 Strip Ash Town White
Oil Engraved #3277



3 Strip Ash Rustic Bitter
Pores Matt Lac. Engraved #3287



3 Strip Walnut Oil Engraved #3301

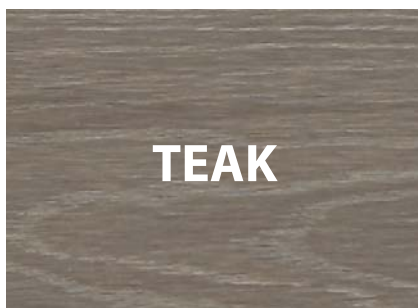
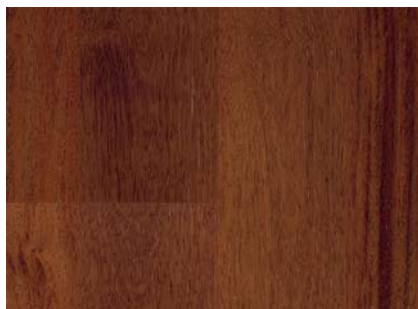
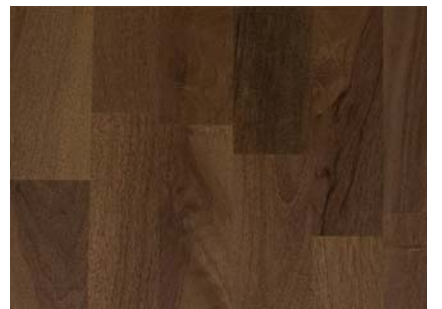



ESTA ART



Oak Silver Moon #3971
Matt Lac. Art



Oak Dune White Pores #8758
Matt Lac. Art



Oak Dusky Grey White Pores #8582
Matt Lac. Art



Oak Kose Matt Lac. Art #8581



Oak Mona Grey Matt Lac. Art #8583



Oak Quartz White Pores #8584
Matt Lac. Art



SPORT LINE



3 Strip Maple Matt Lac. #1357



3 Strip Beech City Matt Lac. #1353



3 Strip Beech Village Matt Lac. #1377

Technomar & Adrem Ltd is committed to conserving the environment and it contributes to sustainable development by responsible and transparent decisions on sourcing of material and the disposal of waste.

Our objective is to live in harmony with nature – now and in the future.

Environmental Policy

This is a sphere of the utmost importance for the company. Our goal is to develop products environmentally friendly and the company is constantly working on it, strictly following the international and national regulations.

The glue, lacquer and oil, we use in the production, are harmless for the environment and health.

We are committed to the sustainability of exotic wood species. By using the latest advancements in wood staining technology on renewable tree species we are able to offer floors in different shades resembling many of the rare exotic wood species. This way we contribute to the preservation of rainforests.

We use our raw materials sparingly, almost without any waste, the off cuts are used for packaging and heating of our factories and offices, thus the minimum expenditures for energy consumption are achieved.

External audits and reviews of our environmental management systems are carried out on a regular basis.

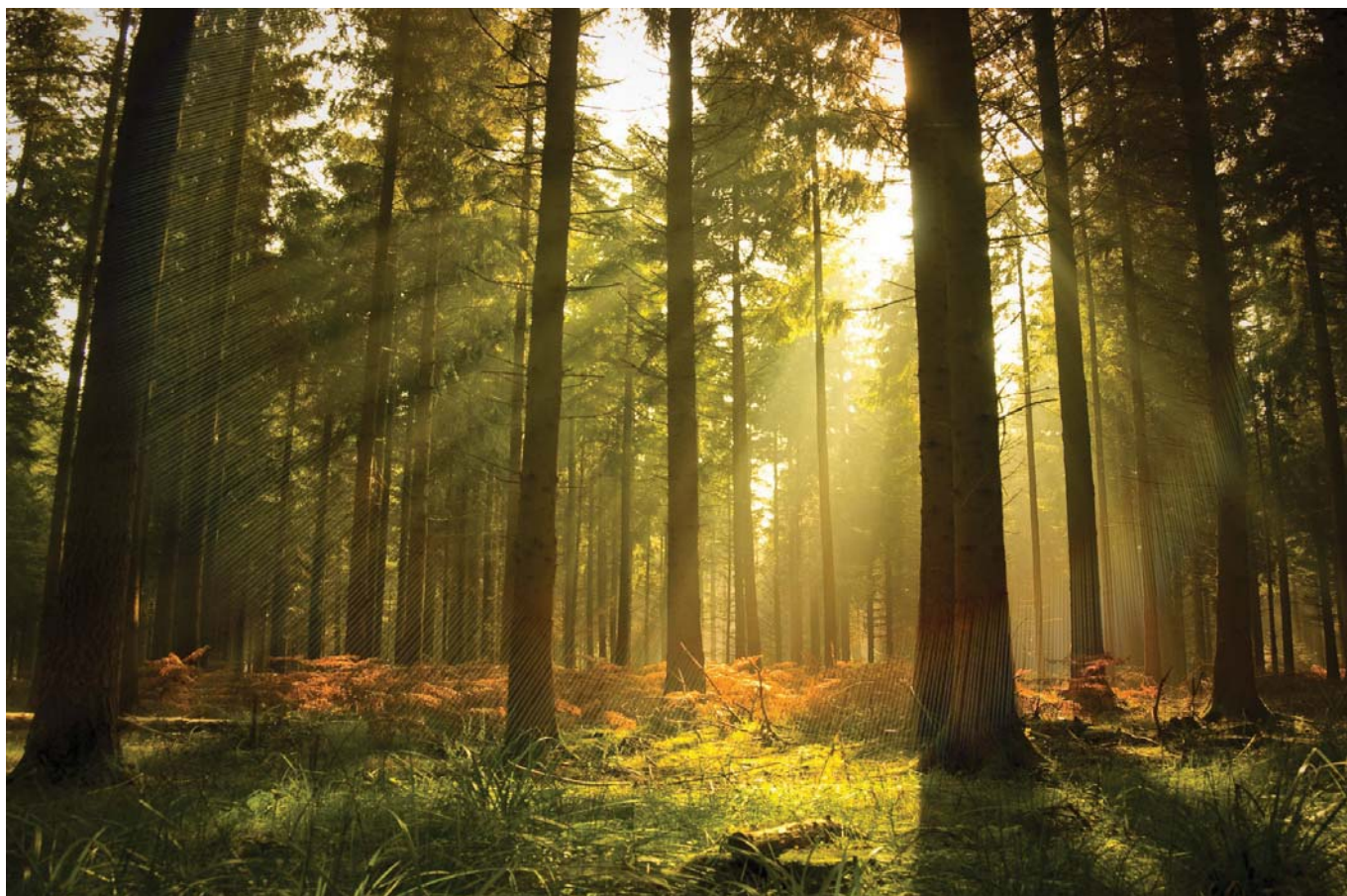

ENVIRONMENTAL POLICY QUALITY CERTIFICATES FOR ESTA PARKET

All ESTA PARKET
products meet the highest quality requirements.

TEST CERTIFICATE CE EN 14342
Certificate for performance of construction
products for the CE marking.

DAR TEST CERTIFICATE
Certificate for the performance of the parquet.

KLUMPP coatings
Certificate for Miraphen UV-Parquet coatings.

ISO 9001
International confirmation of quality,
arranged by Det Norske Veritas.



CE EN 14342



DAR

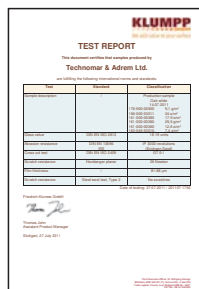

KLUMPP



ISO 9001



Contact

Technomar & Adrem Ltd.

Vana-Narva mnt. 22
74114 Maardu
ESTONIA

Phone +372 603 4865
+372 603 4896

Fax +372 603 4844
+372 603 4845

E-mail: info@estaparket.eu

Website: www.estaparket.eu

Technomar & Adrem AS | www.technomar.ee

